

Features

- 600V Field Stop Trench IGBT Technology
- High Speed Switching
- Low Conduction Loss
- Positive Temperature Coefficient
- Easy Parallel Operation
- Short Circuit Withstanding Time 5 μ s
- 175 $^{\circ}$ C Operating Temperature
- RoHS Compliant
- JEDEC Qualification

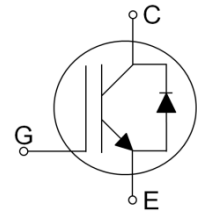
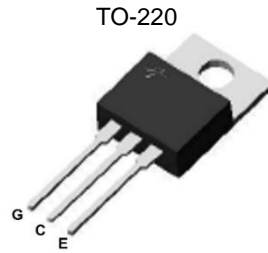

Applications

Motor Drive, Air Conditioner, Inverter, Solar

Device	Package	Marking	Remark
TGP15N60FDR	TO-220	TGP15N60FDR	RoHS

Absolute Maximum Ratings

Parameter	Symbol	Value	Unit
Collector-Emitter Voltage	V_{CES}	600	V
Gate-Emitter Voltage	V_{GES}	± 20	V
Continuous Collector Current	I_C	$T_C = 25^{\circ}\text{C}$	30
		$T_C = 100^{\circ}\text{C}$	15
Pulsed Collector Current (Note 1)	I_{CM}	45	A
Diode Continuous Forward Current	I_F	15	A
Diode Pulsed Forward Current (Note 1)	I_{FM}	100	A
Power Dissipation	P_D	$T_C = 25^{\circ}\text{C}$	100
		$T_C = 100^{\circ}\text{C}$	50
Operating Junction Temperature	T_{vj}	-55 ~ 175	$^{\circ}\text{C}$
Storage Temperature Range	T_{STG}	-55 ~ 150	$^{\circ}\text{C}$
Maximum lead temperature for soldering purposes, 1/8" from case for 5 seconds	T_L	300	$^{\circ}\text{C}$

Notes :

(1) Repetitive rating : Pulse width limited by maximum junction temperature

Thermal Characteristics

Parameter	Symbol	Value	Unit
Maximum Thermal resistance, Junction-to-Case	$R_{\theta JC}$ (IGBT)	1.50	$^{\circ}\text{C}/\text{W}$
Maximum Thermal resistance, Junction-to-Case	$R_{\theta JC}$ (DIODE)	2.35	$^{\circ}\text{C}/\text{W}$
Maximum Thermal resistance, Junction-to-Ambient	$R_{\theta JA}$	62.5	$^{\circ}\text{C}/\text{W}$

Electrical Characteristics of the IGBT $T_{vj}=25^{\circ}\text{C}$, unless otherwise noted

Parameter	Symbol	Test condition	Min.	Typ.	Max.	Unit
OFF						
Collector – Emitter Breakdown Voltage	BV_{CES}	$V_{GE} = 0V, I_C = 1mA$	600	--	--	V
Zero Gate Voltage Collector Current	I_{CES}	$V_{CE} = 600V, V_{GE} = 0V$	--	--	1	mA
Gate – Emitter Leakage Current	I_{GES}	$V_{CE} = 0V, V_{GE} = \pm 20V$	--	--	± 250	nA
Integrated Gate Resistance	$R_{G(int)}$	$f = 1MHz, \text{Open Collector}$	--	14.5	--	Ω
ON						
Gate – Emitter Threshold Voltage	$V_{GE(TH)}$	$V_{GE} = V_{CE}, I_C = 15mA$	4.5	6.0	7.5	V
Collector – Emitter Saturation Voltage	$V_{CE(SAT)}$	$V_{GE} = 15V, I_C = 15A, T_{vj} = 25^{\circ}\text{C}$	--	1.50	2.00	V
		$V_{GE} = 15V, I_C = 15A, T_{vj} = 125^{\circ}\text{C}$	--	1.75	--	
		$V_{GE} = 15V, I_C = 15A, T_{vj} = 175^{\circ}\text{C}$	--	1.85	--	V
DYNAMIC						
Input Capacitance	C_{IES}	$V_{CE} = 30V$ $V_{GE} = 0V$ $f = 1MHz$	--	780	--	pF
Output Capacitance	C_{OES}		--	65	--	pF
Reverse Transfer Capacitance	C_{RES}		--	40	--	pF
Total Gate Charge	Q_g	$V_{CC} = 400V, I_C = 15A$ $V_{GE} = 15V$	--	69	104	nC
Gate-Emitter Charge	Q_{ge}		--	6	9	nC
Gate-Collector Charge	Q_{gc}		--	41	62	nC
SWITCHING (Note 2)						
Turn-On Delay Time	$t_{d(on)}$	$V_{CC} = 400V, I_C = 7.5A$ $R_G = 5\Omega, V_{GE} = 15V$ Inductive Load, $T_{vj} = 25^{\circ}\text{C}$	--	9	--	ns
Rise Time	t_r		--	10	--	ns
Turn-Off Delay Time	$t_{d(off)}$		--	122	--	ns
Fall Time	t_f		--	18	--	ns
Turn-On Switching Loss	E_{ON}		--	0.14	--	mJ
Turn-Off Switching Loss	E_{OFF}		--	0.06	--	mJ
Total Switching Loss	E_{TS}	--	0.20	--	mJ	
Turn-On Delay Time	$t_{d(on)}$	$V_{CC} = 400V, I_C = 15A$ $R_G = 5\Omega, V_{GE} = 15V$ Inductive Load, $T_{vj} = 25^{\circ}\text{C}$	--	10	--	ns
Rise Time	t_r		--	16	--	ns
Turn-Off Delay Time	$t_{d(off)}$		--	108	--	ns
Fall Time	t_f		--	22	--	ns
Turn-On Switching Loss	E_{ON}		--	0.32	0.48	mJ
Turn-Off Switching Loss	E_{OFF}		--	0.16	0.24	mJ
Total Switching Loss	E_{TS}	--	0.48	0.72	mJ	

Electrical Characteristics of the IGBT $T_{vj}=25^{\circ}\text{C}$, unless otherwise noted

Parameter	Symbol	Test condition	Min.	Typ.	Max.	Unit
SWITCHING (Note 2)						
Turn-On Delay Time	$t_{d(on)}$	$V_{CC} = 400\text{V}$, $I_C = 7.5\text{A}$ $R_G = 5\Omega$, $V_{GE} = 15\text{V}$ Inductive Load, $T_{vj} = 175^{\circ}\text{C}$	--	8	--	ns
Rise Time	t_r		--	10	--	ns
Turn-Off Delay Time	$t_{d(off)}$		--	160	--	ns
Fall Time	t_f		--	77	--	ns
Turn-On Switching Loss	E_{ON}		--	0.31	--	mJ
Turn-Off Switching Loss	E_{OFF}		--	0.17	--	mJ
Total Switching Loss	E_{TS}	--	0.48	--	mJ	
Turn-On Delay Time	$t_{d(on)}$	$V_{CC} = 400\text{V}$, $I_C = 15\text{A}$ $R_G = 5\Omega$, $V_{GE} = 15\text{V}$ Inductive Load, $T_{vj} = 175^{\circ}\text{C}$	--	14	--	ns
Rise Time	t_r		--	12	--	ns
Turn-Off Delay Time	$t_{d(off)}$		--	140	--	ns
Fall Time	t_f		--	84	--	ns
Turn-On Switching Loss	E_{ON}		--	0.57	0.86	mJ
Turn-Off Switching Loss	E_{OFF}		--	0.35	0.53	mJ
Total Switching Loss	E_{TS}	--	0.92	1.38	mJ	
Short Circuit Withstanding Time	t_{SC}	$V_{CC} = 300\text{V}$, $V_{GE} = 15\text{V}$, $T_{vj} = 125^{\circ}\text{C}$	5	--	--	μs

Notes :

(2) Not subject to production test – verified by design/characterization

Electrical Characteristics of the DIODE $T_{vj}=25^{\circ}\text{C}$, unless otherwise noted

Parameter	Symbol	Test condition	Min.	Typ.	Max.	Unit
Diode Forward Voltage	V_{FM}	$I_F = 7.5\text{A}, T_{vj} = 25^{\circ}\text{C}$	--	1.59	--	V
		$I_F = 7.5\text{A}, T_{vj} = 125^{\circ}\text{C}$	--	1.35	--	V
		$I_F = 7.5\text{A}, T_{vj} = 175^{\circ}\text{C}$	--	1.21	--	V
		$I_F = 15\text{A}, T_{vj} = 25^{\circ}\text{C}$	--	1.91	--	V
		$I_F = 15\text{A}, T_{vj} = 125^{\circ}\text{C}$	--	1.69	--	V
		$I_F = 15\text{A}, T_{vj} = 175^{\circ}\text{C}$	--	1.61	--	V
Reverse Recovery Time	t_{rr}	$I_F = 7.5\text{A},$ $di/dt = 200\text{A}/\mu\text{s},$ $T_{vj} = 25^{\circ}\text{C}$	--	46	--	ns
Reverse Recovery Current	I_{rr}		--	3.9	--	A
Reverse Recovery Charge	Q_{rr}		--	99	--	nC
Reverse Recovery Time	t_{rr}	$I_F = 7.5\text{A},$ $di/dt = 200\text{A}/\mu\text{s},$ $T_{vj} = 175^{\circ}\text{C}$	--	109	--	ns
Reverse Recovery Current	I_{rr}		--	8.0	--	A
Reverse Recovery Charge	Q_{rr}		--	525	--	nC
Reverse Recovery Time	t_{rr}	$I_F = 15\text{A},$ $di/dt = 200\text{A}/\mu\text{s},$ $T_{vj} = 25^{\circ}\text{C}$	--	50	--	ns
Reverse Recovery Current	I_{rr}		--	4.8	--	A
Reverse Recovery Charge	Q_{rr}		--	143	--	nC
Reverse Recovery Time	t_{rr}	$I_F = 15\text{A},$ $di/dt = 200\text{A}/\mu\text{s},$ $T_{vj} = 175^{\circ}\text{C}$	--	121	--	ns
Reverse Recovery Current	I_{rr}		--	10.0	--	A
Reverse Recovery Charge	Q_{rr}		--	695	--	nC

IGBT Characteristics

Fig. 1 IGBT Output Characteristics

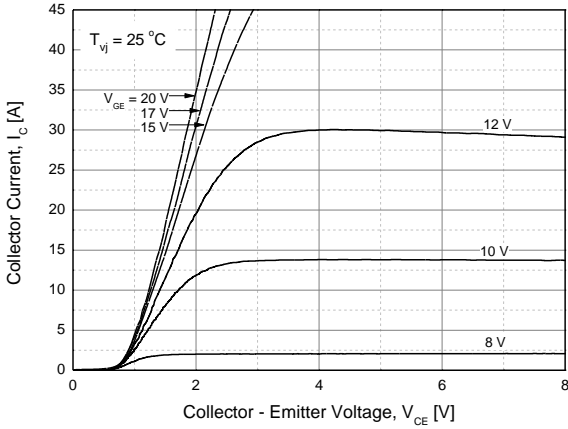

Fig. 2 IGBT Output Characteristics

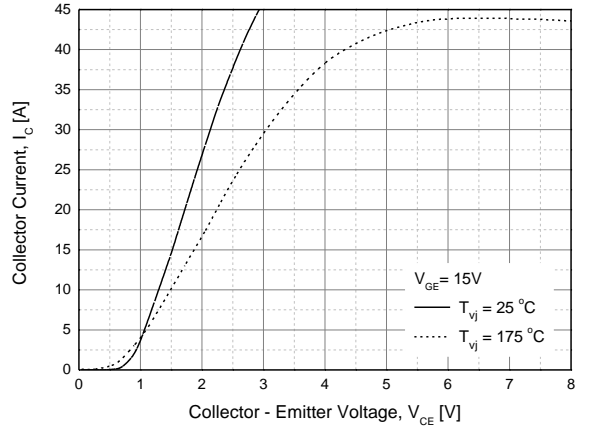

Fig. 3 IGBT Saturation Voltage vs. Junction Temperature

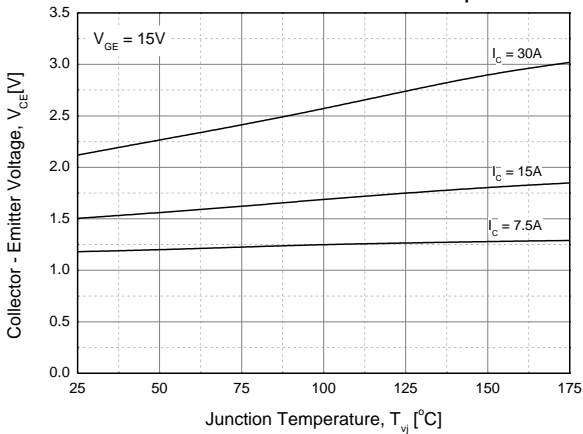

Fig. 4 IGBT Saturation Voltage vs. Gate Bias

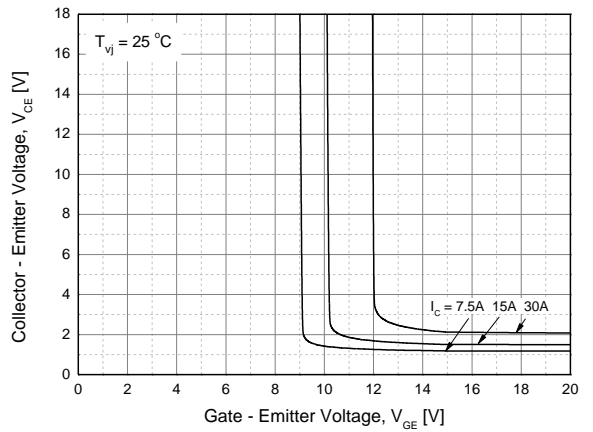

Fig. 5 IGBT Saturation Voltage vs. Gate Bias

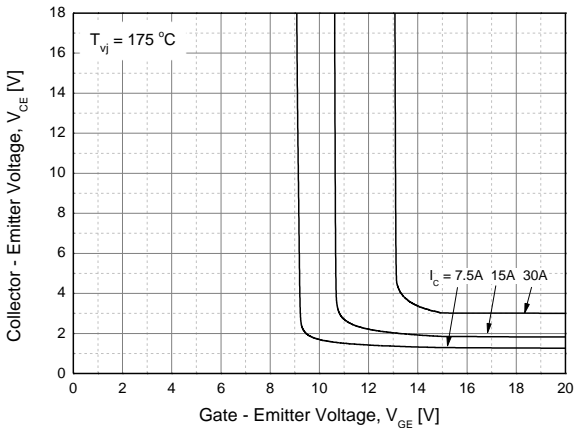
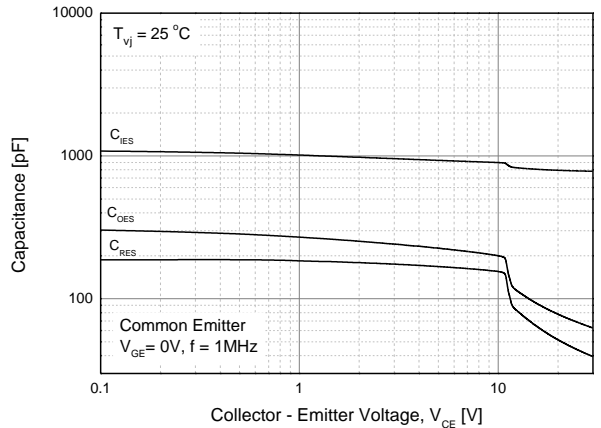

Fig. 6 IGBT Capacitance Characteristics



IGBT Characteristics

Fig. 7 Turn-on Time vs. Gate Resistor

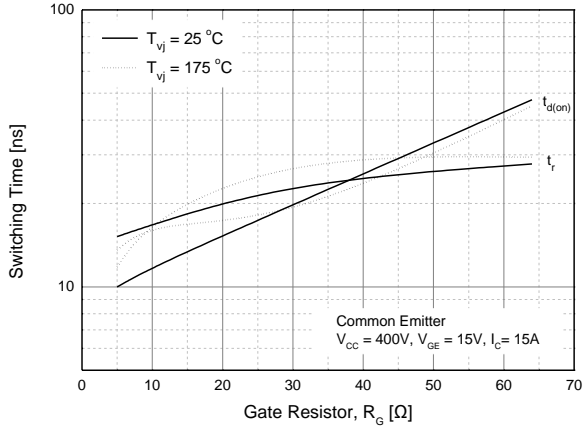

Fig. 8 Turn-off Time vs. Gate Resistor

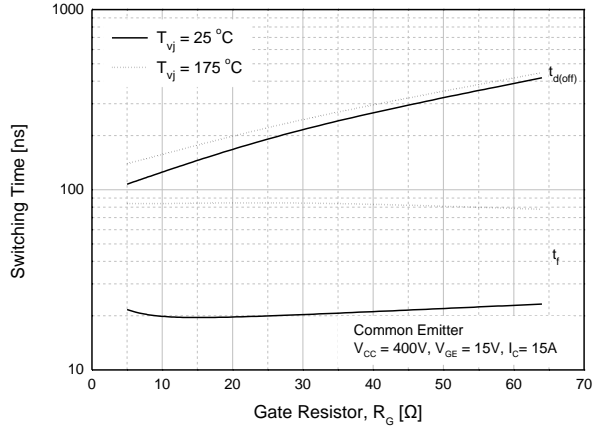

Fig. 9 Switching Loss vs. Gate Resistor

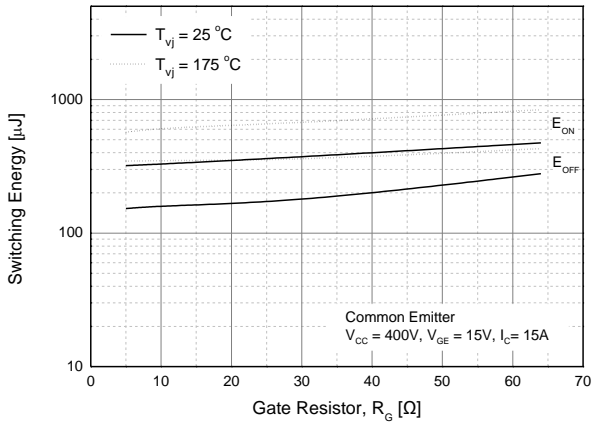

Fig. 10 Turn-on Time vs. Collector Current

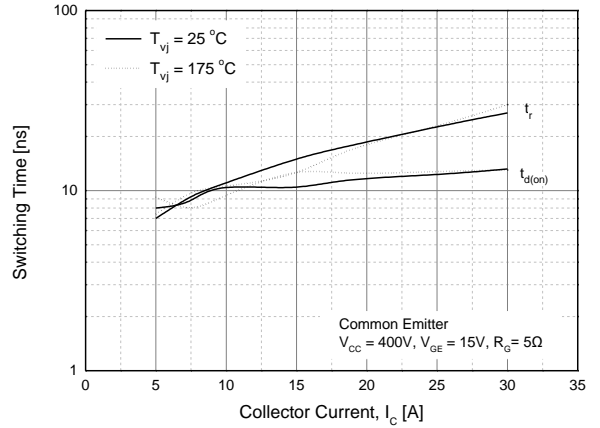

Fig. 11 Turn-off Time vs. Collector Current

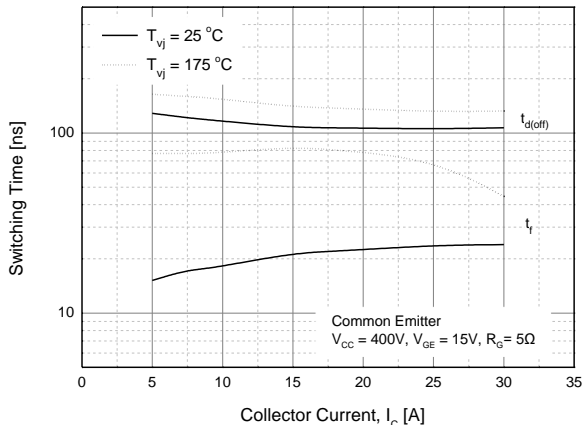
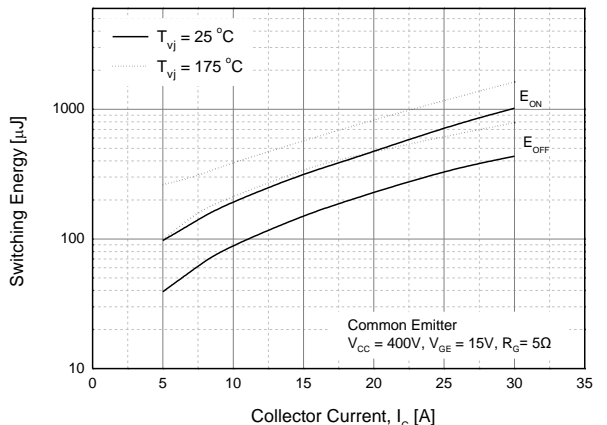

Fig. 12 Switching Loss vs. Collector Current



IGBT Characteristics

Fig. 13 Gate Charge Characteristics

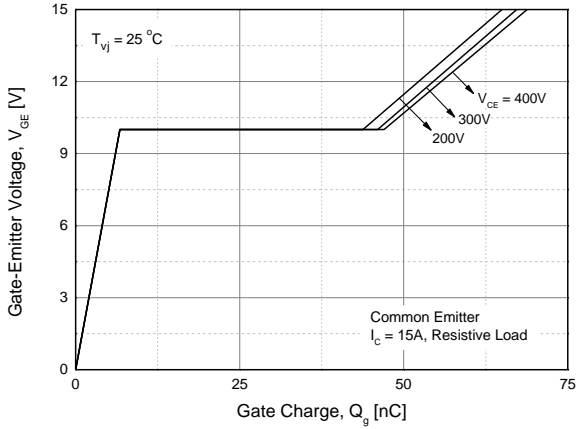

Fig. 14 SOA

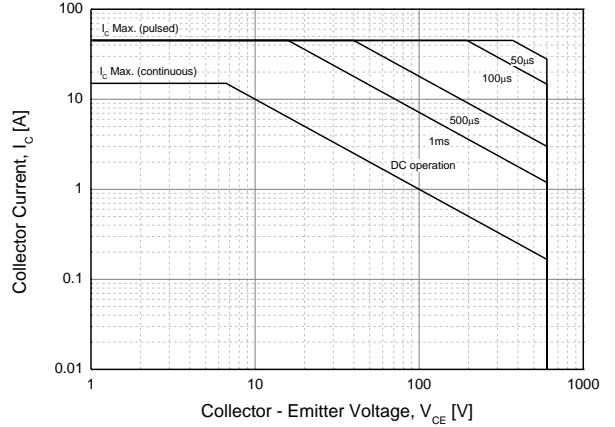

Fig. 15 RBSOA

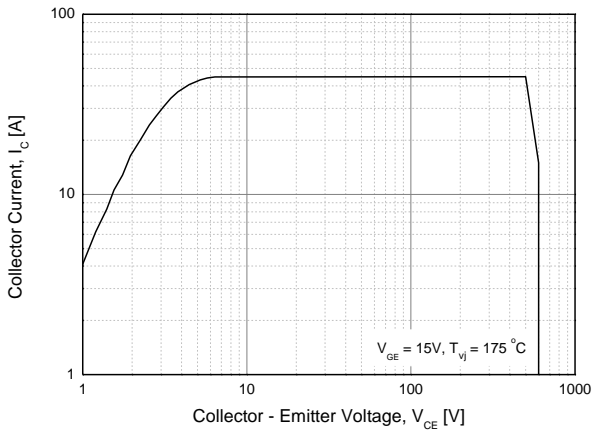

Fig. 16 Transient Thermal Impedance of IGBT

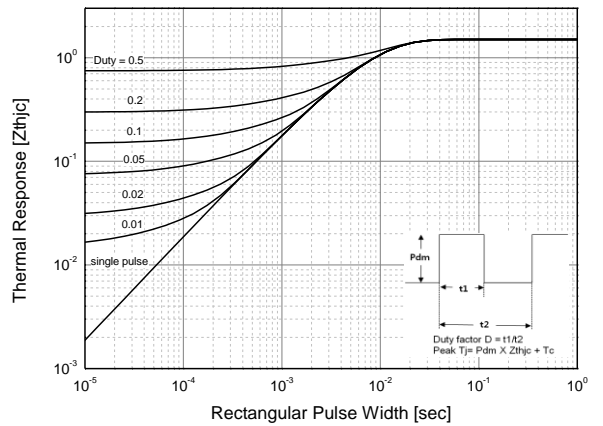
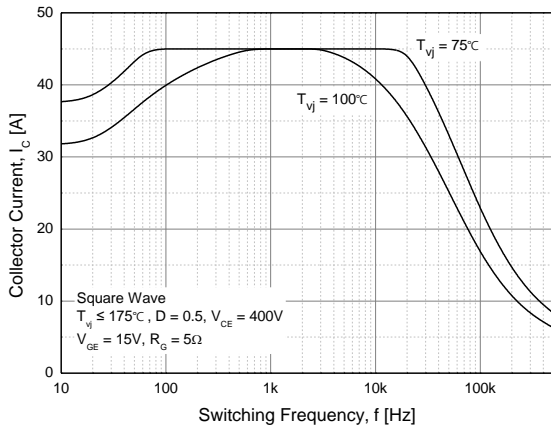

Fig. 17 Load Current vs. Frequency



DIODE Characteristics

Fig. 18 Diode Conduction Characteristics

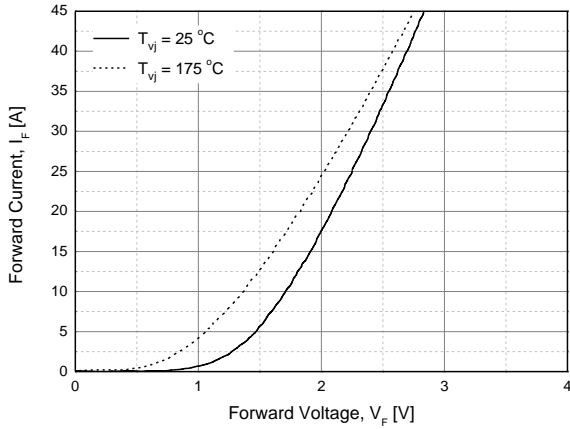

Fig. 19 Reverse Recovery Current vs. Forward Current

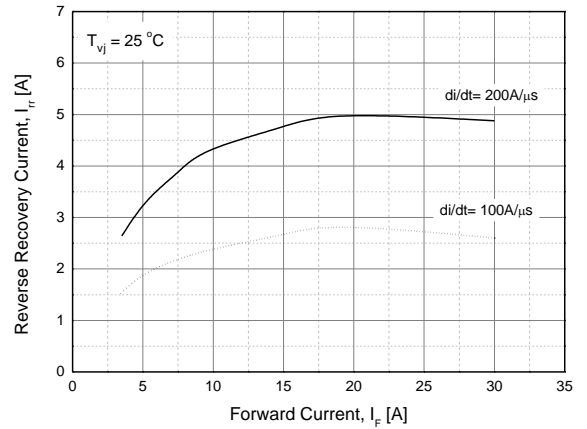

Fig. 20 Reverse Recovery Charge vs. Forward Current

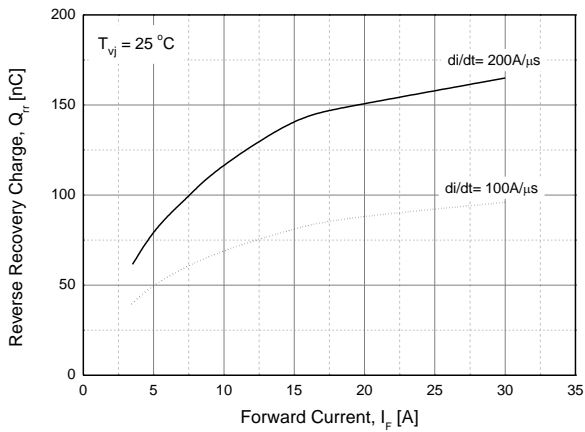
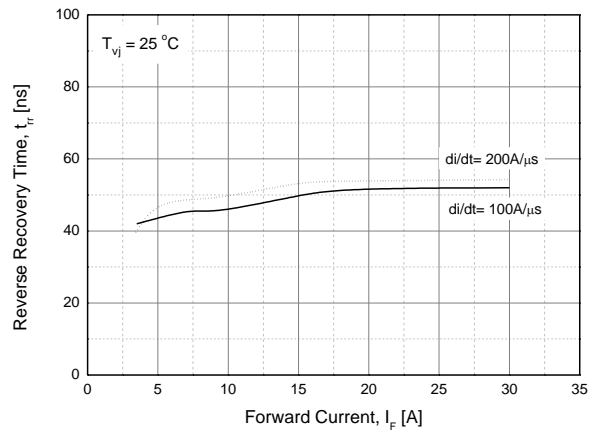
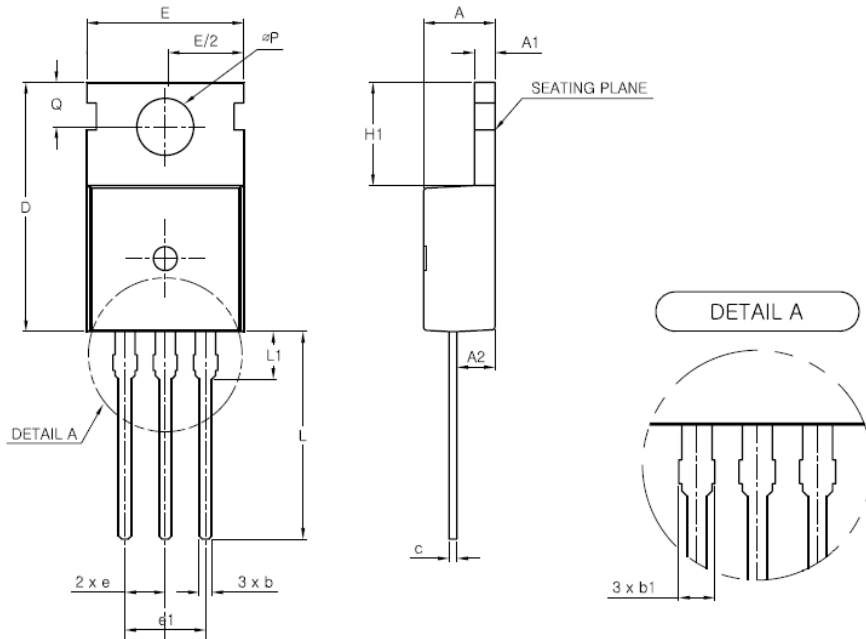

Fig. 21 Reverse Recovery Time vs. Forward Current



TO-220AB-3L MECHANICAL DATA



SYMBOL	MIN	MAX
A	4.30	4.70
A1	1.22	1.40
A2	2.20	2.79
b	0.70	0.91
b1	1.15	1.62
c	0.36	0.60
D	14.99	15.90
E	9.70	10.41
e	2.54 TYP	
e1	5.08 BSC	
H1	5.97	6.70
L	12.88	13.97
L1	3.31	3.81
ØP	3.40	3.88
Q	2.60	2.90

Disclaimer

TRinno technology reserves the right to make changes without notice to products herein to improve reliability, performance, or design. The information given in this document is believed to be accurate and reliable. However, it shall in no event be regarded as a guarantee of conditions and characteristics. With respect to any information regarding the application of the device, TRinno technology hereby disclaims any and all warranties and liabilities of any kind, including without limitation, warranties of non-infringement of patent rights of any third party.